

1. This guideline applies to:

- Structural sections as listed below, loaded web horizontal in vertical tiers on timber dunnage.

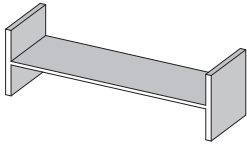

Universal  
beams

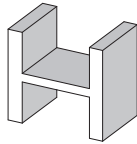

Universal  
columns

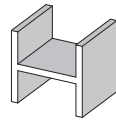

Universal  
bearing piles

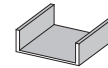

Parallel flange  
channels

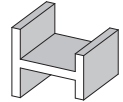

Asymmetric  
beams

- Mill finish steel-on-steel static coefficient of friction  $\mu_s = 0.42$ ; tested according to EN 12195-1:2010 Annex C.

Note: If steel is painted or galvanised it is classed as low friction and additional restraint is required.

2. Essential requirements

- All restraints must be transport chains compliant with EN 12195-3:2001 (Grade 8 chain).
- Base dunnage must be a single layer of square section timber.
- Minimum 4-off base dunnage on standard trailers and 5-off on extendable trailers.
- Side pins. 6-off recommended. (Omitted for clarity on some images).

3. Overview of restraint system

Full load (28 tonnes) on a standard trailer restrained using 8mm chains:

- ✓ 3 belly-wrapped and 4 **over-the-top** chains.
- ✓ Restraints are a minimum of 500mm from front and rear of product.
- ✓ Restraints are placed close to dunnage.
- ✓ 4-off square section timber dunnage.
- ✓ Side pins.

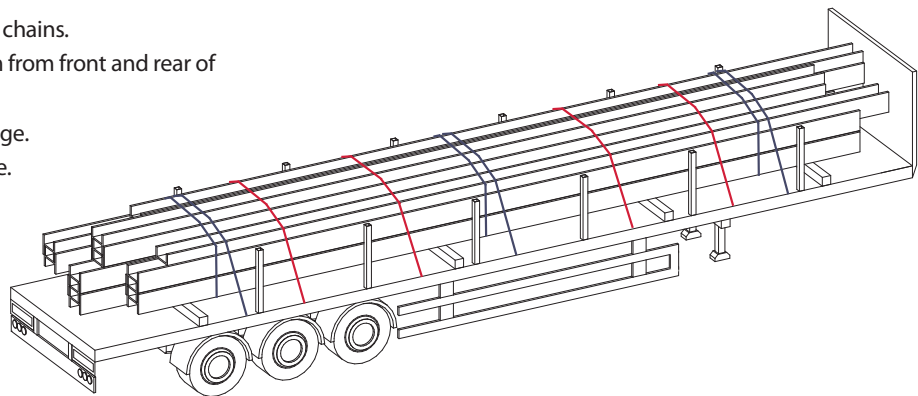

Table 1: 8mm chains (4-tonne lashing capacity)

Load	Belly-wrap		Over-the-top		Total
0-10 t	3	+	0	=	3
10-15 t	3	+	1	=	4
15-20 t	3	+	2	=	5
20-25 t	3	+	3	=	6
25-28 t	3	+	4	=	7

Table 2: 10mm chains (6.3-tonne lashing capacity)

Load	Belly-wrap		Over-the-top		Total
0-10 t	2	+	0	=	2
10-15 t	2	+	0	=	2
15-20 t	2	+	1	=	3
20-25 t	2	+	2	=	4
25-28 t	2	+	3	=	5

This Load Restraint Guideline is designed to be compliant with the forces stated in EN 12195-1:2010 and VDI 2700.

#### 4. Load configuration

##### 4.1 Pyramid

- The chain must deflect by a minimum of 20 degrees from one tier to the next.
- All product in each tier must be the same section size.

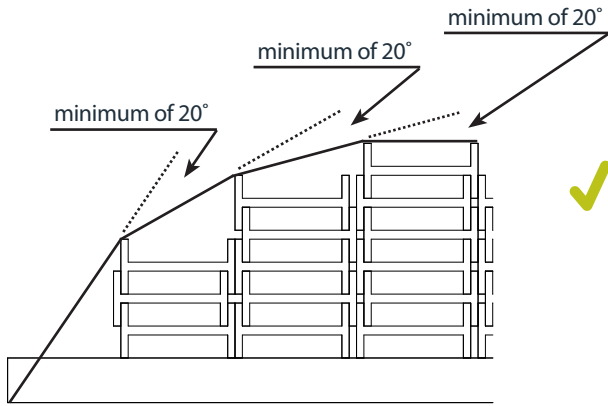
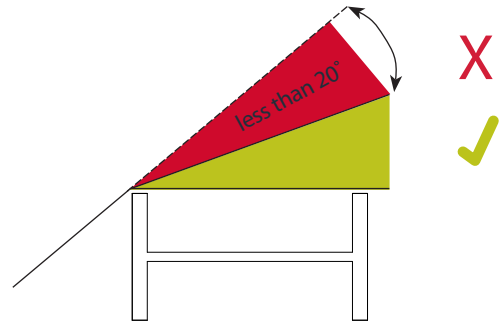

Minimum of 20° deflection at each tier.

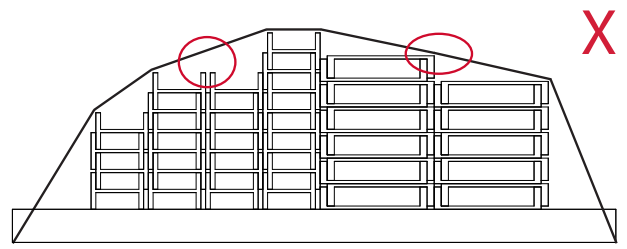

No contact with tier and negligible chain deflection.

##### 4.2 Block

- Block configuration loads cannot be restrained to EN 12195-1:2010 using over-the-top or belly-wrap chains alone.
- These loads must be reconfigured to allow downward clamping to be applied to all tiers. This can be accomplished by introducing intermediate timber dunnage.

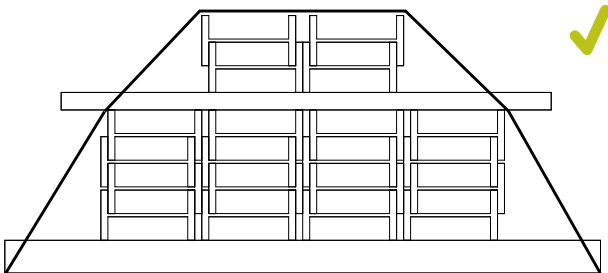
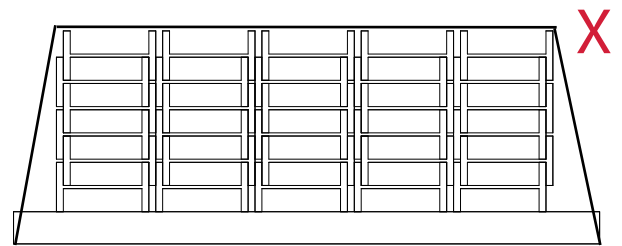

- Maximum of 2 tiers on top of the intermediate dunnage.
- Product between the base dunnage and intermediate dunnage must be of the identical section size, with the same quantity in each vertical tier.

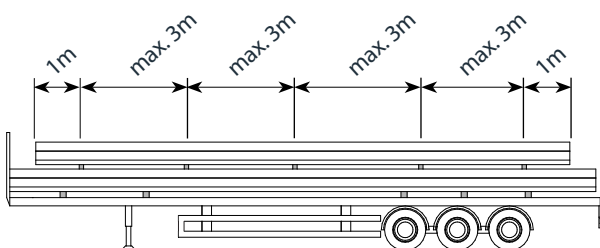

- Intermediate timber dunnage must be a minimum of 100 x 100mm square section and span the full width of the product below it.
- Intermediate dunnage to be placed 1 metre from ends of shortest product and a maximum spacing of 3 metres between each.



### 4.3 Interlocked sections

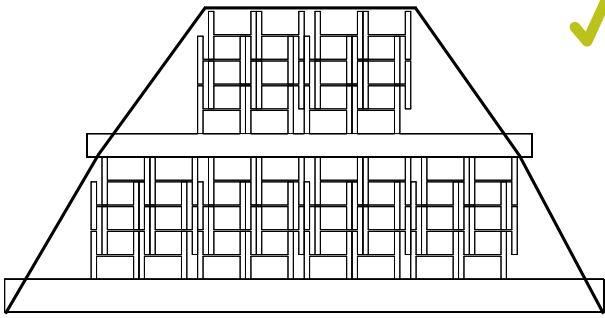

- 2 bundles of interlocked sections may be placed on top of the intermediate dunnage. 2 bundles = 4 tiers.
- Testing of this specific load configuration has shown that the belly-wrapped chains in combination with the over-the-top chains will restrain a full load to the forces specified in EN 12195-1:2010 and VDI 2700.

### 5. Short and long loads

- Do not stack the majority of the weight over the centre of extendable trailers.
- This can lead to trailer damage and difficulty supporting short lengths adequately.
- Maximum difference in length between shortest and longest bar is 6 metres.

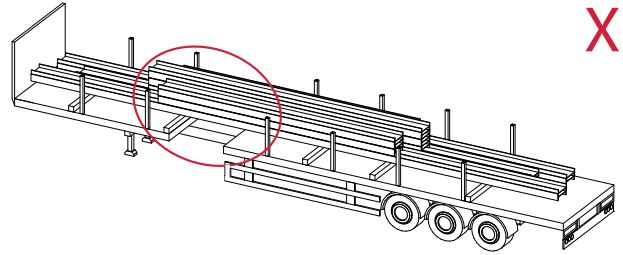

- Short lengths may be loaded one behind the other. Each group of product is to be treated separately to determine restraint requirements.

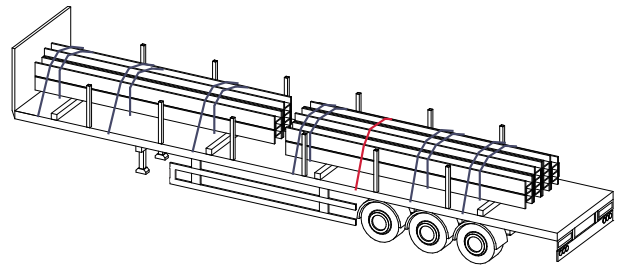

- When loading long product on short product, restraints must be placed within the length of the short product and NOT at the overhanging portions.

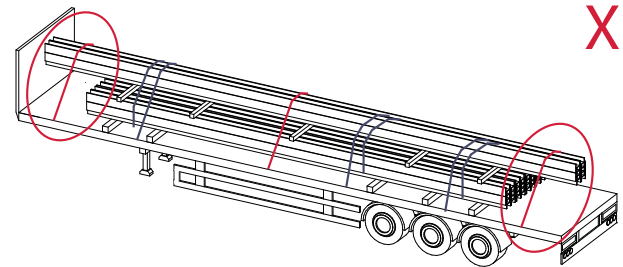

### 6. Gaps between tiers

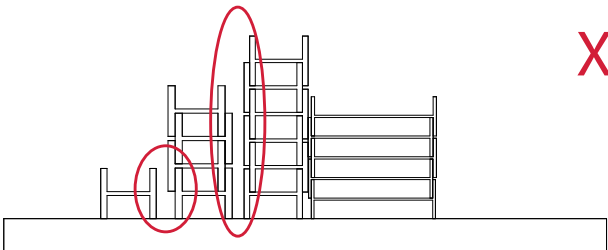

- When loading with a forklift, gaps between tiers must be closed as far as is reasonably practicable.

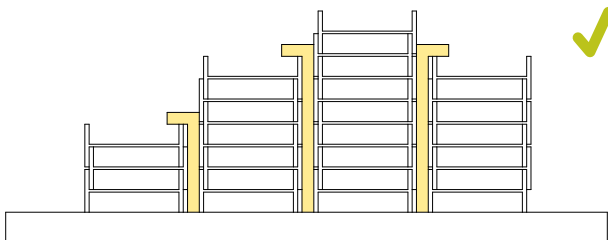

- When gaps between tiers are required for loading/unloading, then suitable means of controlling the chain gaps must be implemented.
- Vertical dunnage must be securely fixed in place to prevent this coming loose in transit.



## 7. Placement of restraints

- ✓ Belly-wraps to be placed such that they wrap around all tiers.
- ✓ Restraints to be placed close to timbers, preferably in front.
- ✓ Restraints to be placed a minimum of 500mm from end of any product, to prevent product diving under restraints.

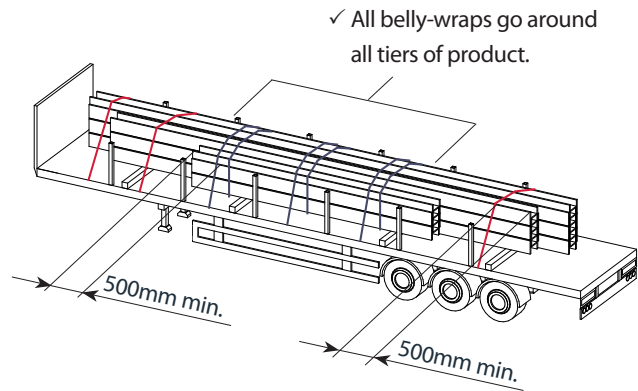

## 8. Other loading considerations

- Maximum product height above the trailer deck is 1.5 metres.
- Product may be loaded away from headboard to achieve correct axle loadings.

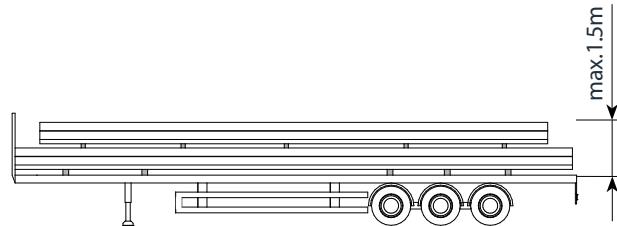

Depending on customer off-loading restrictions, the following may be considered when load building to create the required chain angles:

Narrow beams being placed on top need to be positioned towards the centre of the trailer.

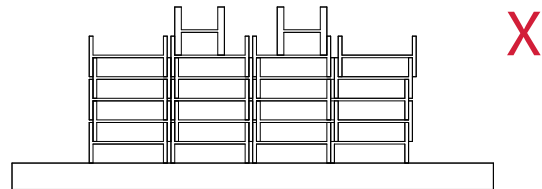
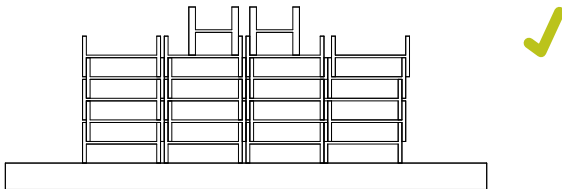

Product placed on top must sit with both its flanges on the webs of the two tiers below it.

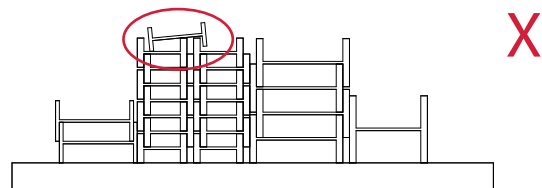

Wide beams being placed on top must only span two tiers.

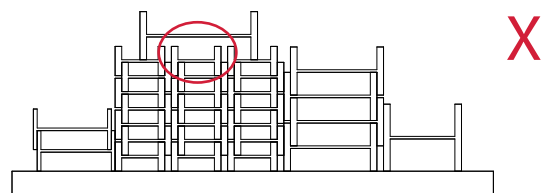
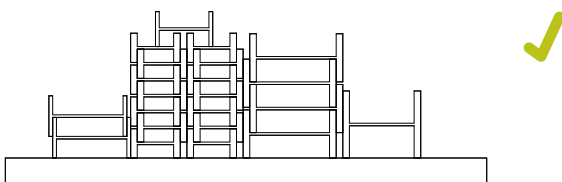

**BRITISHSTEEL.CO.UK**

A | PO Box 1, Brigg Road, Scunthorpe, North Lincolnshire, DN16 1BP  
T | +44 (0)1724 402436 E | [getintouch@longssteel.com](mailto:getintouch@longssteel.com)

LRG-0002-SS British Steel Issue 2

Care has been taken to ensure that the contents of this publication are accurate, but British Steel UK Limited and its subsidiaries and associated undertakings (having the meaning set out in the Companies Act 2006) do not accept responsibility or liability for errors or information that is found to be misleading.

Copyright British Steel 2016

British Steel UK Limited is registered in England under number 09438207 with registered office at Administration Building, Brigg Road, Scunthorpe, DN16 1BP.

